

# Network Cube Camera

Quick Start Guide

### **About this Manual**

The Manual includes instructions for using and managing the Product. Pictures, charts, images and all other information hereinafter are for description and explanation only. The information contained in the Manual is subject to change, without notice, due to firmware updates or other reasons. Please find the latest version of this Manual at the company website

Please use this Manual with the guidance and assistance of professionals trained in supporting the Product.

### **Trademarks Acknowledgement**

Trademarks and logos mentioned are the properties of their respective owners.

### **Legal Disclaimer**

TO THE MAXIMUM EXTENT PERMITTED BY APPLICABLE LAW, THIS MANUAL AND THE PRODUCT DESCRIBED, WITH ITS HARDWARE, SOFTWARE AND FIRMWARE, ARE PROVIDED “AS IS” AND “WITH ALL FAULTS AND ERRORS”. OUR COMPANY MAKES NO WARRANTIES, EXPRESS OR IMPLIED, INCLUDING WITHOUT LIMITATION, MERCHANTABILITY, SATISFACTORY QUALITY, OR FITNESS FOR A PARTICULAR PURPOSE. THE USE OF THE PRODUCT BY YOU IS AT YOUR OWN RISK. IN NO EVENT WILL OUR COMPANY BE LIABLE TO YOU FOR ANY SPECIAL, CONSEQUENTIAL, INCIDENTAL, OR INDIRECT DAMAGES, INCLUDING, AMONG OTHERS, DAMAGES FOR LOSS OF BUSINESS PROFITS, BUSINESS INTERRUPTION, OR LOSS OF DATA, CORRUPTION OF SYSTEMS, OR LOSS OF DOCUMENTATION, WHETHER BASED ON BREACH OF CONTRACT, TORT (INCLUDING NEGLIGENCE), PRODUCT LIABILITY, OR OTHERWISE, IN CONNECTION

WITH THE USE OF THE PRODUCT, EVEN IF OUR COMPANY HAS BEEN ADVISED OF THE POSSIBILITY OF SUCH DAMAGES OR LOSS.

YOU ACKNOWLEDGE THAT THE NATURE OF INTERNET PROVIDES FOR INHERENT SECURITY RISKS, AND OUR COMPANY SHALL NOT TAKE ANY RESPONSIBILITIES FOR ABNORMAL OPERATION, PRIVACY LEAKAGE OR OTHER DAMAGES RESULTING FROM CYBER-ATTACK, HACKER ATTACK, VIRUS INSPECTION, OR OTHER INTERNET SECURITY RISKS; HOWEVER, OUR COMPANY WILL PROVIDE TIMELY TECHNICAL SUPPORT IF REQUIRED.

YOU AGREE TO USE THIS PRODUCT IN COMPLIANCE WITH ALL APPLICABLE LAWS, AND YOU ARE SOLELY RESPONSIBLE FOR ENSURING THAT YOUR USE CONFORMS TO THE APPLICABLE LAW. ESPECIALLY, YOU ARE RESPONSIBLE, FOR USING THIS PRODUCT IN A MANNER THAT DOES NOT INFRINGE ON THE RIGHTS OF THIRD PARTIES, INCLUDING WITHOUT LIMITATION, RIGHTS OF PUBLICITY, INTELLECTUAL PROPERTY RIGHTS, OR DATA PROTECTION AND OTHER PRIVACY RIGHTS. YOU SHALL NOT USE THIS PRODUCT FOR ANY PROHIBITED END-USES, INCLUDING THE DEVELOPMENT OR PRODUCTION OF WEAPONS OF MASS DESTRUCTION, THE DEVELOPMENT OR PRODUCTION OF CHEMICAL OR BIOLOGICAL WEAPONS, ANY ACTIVITIES IN THE CONTEXT RELATED TO ANY NUCLEAR EXPLOSIVE OR UNSAFE NUCLEAR FUEL-CYCLE, OR IN SUPPORT OF HUMAN RIGHTS ABUSES.

IN THE EVENT OF ANY CONFLICTS BETWEEN THIS MANUAL AND THE APPLICABLE LAW, THE LATER PREVAILS.

## **Regulatory Information**

### **FCC Information**

Please take attention that changes or modification not expressly approved by the party responsible for compliance could void the user's authority to operate the equipment.

**FCC compliance:** This equipment has been tested and found to comply with the limits for a Class B digital device, pursuant to part 15 of the FCC Rules. These limits are designed to provide reasonable protection against harmful interference in a residential installation. This equipment generates, uses and can radiate radio frequency energy and, if not installed and used in accordance with the instructions, may cause harmful interference to radio communications. However, there is no guarantee that interference will not occur in a particular installation. If this equipment does cause harmful interference to radio or television reception, which can be determined by turning the equipment off and on, the user is encouraged to try to correct the interference by one or more of the following measures:

- Reorient or relocate the receiving antenna.
- Increase the separation between the equipment and receiver.
- Connect the equipment into an outlet on a circuit different from that to which the receiver is connected.
- Consult the dealer or an experienced radio/TV technician for help.

This equipment should be installed and operated with a minimum distance 20cm between the radiator and your body.

### **FCC Conditions**

This device complies with part 15 of the FCC Rules. Operation is subject to the following two conditions:

1. This device may not cause harmful interference.

2. This device must accept any interference received, including interference that may cause undesired operation.

## **EU Conformity Statement**



This product and - if applicable - the supplied accessories too are marked with "CE" and comply therefore with the applicable harmonized European standards listed under the EMC Directive 2014/30/EU, the RoHS Directive 2011/65/EU, RE Directive 2014/53/EU.



2012/19/EU (WEEE directive): Products marked with this symbol cannot be disposed of as unsorted municipal waste in the European Union. For proper recycling, return this product to your local supplier upon the purchase of equivalent new equipment, or dispose of it at designated collection points. For more information see: [www.recyclethis.info](http://www.recyclethis.info)



2006/66/EC (battery directive): This product contains a battery that cannot be disposed of as unsorted municipal waste in the European Union. See the product documentation for specific battery information. The battery is marked with this symbol, which may include lettering to indicate cadmium (Cd), lead (Pb), or mercury (Hg). For proper recycling, return the battery to your supplier or to a designated collection point. For more information see: [www.recyclethis.info](http://www.recyclethis.info)

## **Industry Canada ICES-003 Compliance**

This device meets the CAN ICES-3 (B)/NMB-3(B) standards requirements.

This device complies with Industry Canada licence-exempt RSS standard(s). Operation is subject to the following two conditions:

- (1) this device may not cause interference, and
- (2) this device must accept any interference, including interference that may cause undesired operation of the device.

Le présent appareil est conforme aux CNR d'Industrie Canada applicables aux appareils radioexempts de licence. L'exploitation est autorisée aux deux conditions suivantes:

- (1) l'appareil ne doit pas produire de brouillage, et
- (2) l'utilisateur de l'appareil doit accepter tout brouillage radioélectrique subi, même si le brouillage est susceptible d'en compromettre le fonctionnement.

Under Industry Canada regulations, this radio transmitter may only operate using an antenna of a type and maximum (or lesser) gain approved for the transmitter by Industry Canada. To reduce potential radio interference to other users, the antenna type and its gain should be so chosen that the equivalent isotropically radiated power (e.i.r.p.) is not more than that necessary for successful communication.

Conformément à la réglementation d'Industrie Canada, le présent émetteur radio peut fonctionner avec une antenne d'un type et d'un gain maximal (ou inférieur) approuvé pour l'émetteur par Industrie Canada. Dans le but de réduire les risques de brouillage radioélectrique à l'intention des autres utilisateurs, il faut choisir le type d'antenne et son gain de sorte que la puissance isotrope rayonnée équivalente (p.i.r.e.) ne dépasse pas l'intensité nécessaire à l'établissement d'une communication satisfaisante.

This equipment should be installed and operated with a minimum distance 20cm between the radiator and your body.

Cet équipement doit être installé et utilisé à une distance minimale de 20 cm entre le radiateur et votre corps.



## Safety Instruction

These instructions are intended to ensure that user can use the product correctly to avoid danger or property loss.

The precaution measure is divided into “Warnings” and “Cautions”

**Warnings:** Serious injury or death may occur if any of the warnings are neglected.

**Cautions:** Injury or equipment damage may occur if any of the cautions are neglected.

	
<b>Warnings</b> Follow these safeguards to prevent serious injury or death.	<b>Cautions</b> Follow these precautions to prevent potential injury or material damage.



### Warnings

- CAUTION: Hot parts! Burned fingers when handling the parts.



Wait one-half hour after switching off before handling parts. This sticker is to indicate that the marked item can be hot and should not be

touched without taking care. For device with this sticker, this device is intended for installation in a restricted access location, access can only be gained by service persons or by users who have been instructed about the reasons for the restrictions applied to the location and about any precautions that shall be taken.

- In the use of the product, you must be in strict compliance with the electrical safety regulations of the nation and region. Please refer to technical specifications for detailed information.
- The power source should meet limited power source or PS2 requirements according to IEC 60950-1 or IEC 62368-1 standard. Please refer to technical specifications for detailed information.
- Do not connect several devices to one power adapter as adapter overload may cause over-heating or a fire hazard.
- Please make sure that the plug is firmly connected to the power socket. When the product is mounted on wall or ceiling, the device shall be firmly fixed.
- If smoke, odor or noise rise from the device, turn off the power at once and unplug the power cable, and then please contact the service center.
- Proper configuration of all passwords and other security settings is the responsibility of the installer and/or end-user.



### Cautions

- Make sure the power supply voltage is correct before using the camera.



- Do not drop the camera or subject it to physical shock.
- Do not touch sensor modules with fingers. If cleaning is necessary, use clean cloth with a bit of ethanol and wipe it gently. If the camera will not be used for an extended period, please replace the lens cap to protect the sensor from dirt.
- Do not aim the camera at the sun or extra bright places. Blooming or smearing may occur otherwise (which is not a malfunction), and affect the endurance of sensor at the same time.
- The sensor may be burned out by a laser beam, so when any laser equipment is in using, make sure that the surface of sensor will not be exposed to the laser beam.
- Do not place the camera in extremely hot, cold (the operating temperature shall be  $-10^{\circ}\text{C}$  to  $+40^{\circ}\text{C}$  ( $14^{\circ}\text{F}$  to  $104^{\circ}\text{F}$ )), dusty or damp locations, and do not expose it to high electromagnetic radiation.
- To avoid heat accumulation, good ventilation is required for operating environment.
- Keep the camera away from liquid while in use.
- While in delivery, the camera shall be packed in its original packing, or packing of the same texture.
- Regular part replacement: a few parts (e.g. electrolytic capacitor) of the equipment shall be replaced regularly according to their average enduring time. The average time varies because of differences between operating environment and using history, so regular checking is recommended for all the users. Please contact with your dealer for more details.

- This equipment is not suitable for use in locations where children are likely to be present.
- CAUTION: Risk of explosion if the battery is replaced by an incorrect type. Dispose of used batteries according to the instructions

ATTENTION: IL Y A RISQUE D'EXPLOSION SI LA BATTERIE EST REMPLACÉE PAR UNE BATTERIE DE TYPE INCORRECT. METTRE AU REBUT LES BATTERIES USAGÉES CONFORMÉMENT AUX INSTRUCTIONS

- Improper replacement of the battery with an incorrect type may defeat a safeguard (for example, in the case of some lithium battery types).
- Do not dispose of the battery into fire or a hot oven, or mechanically crush or cut the battery, which may result in an explosion.
- Do not leave the battery in an extremely high temperature surrounding environment, which may result in an explosion or the leakage of flammable liquid or gas.
- Do not subject the battery to extremely low air pressure, which may result in an explosion or the leakage of flammable liquid or gas.
- If the product does not work properly, please contact your dealer or the nearest service center. Never attempt to disassemble the camera yourself. (We shall not assume any responsibility for problems caused by unauthorized repair or maintenance.)

## Table of Contents

<b>1 Appearance Description .....</b>	<b>11</b>
1.1 Type I, II.....	11
1.2 Type III .....	14
<b>2 Notice .....</b>	<b>18</b>
<b>3 Installation.....</b>	<b>20</b>
3.1 Memory Card Installation.....	20
3.1.1 Type I, II.....	21
3.1.2 Type III.....	21
3.2 Type I, II Camera Mounting .....	22
3.2.1 Stand Mounting.....	22
3.2.2 Ceiling Mounting .....	23
3.3 Type III Camera Mounting .....	26

# 1 Appearance Description

---

There are three types of appearances. Please refer to the figure below. And one appearance will be taken as an example in the chapter below.

## 1.1 Type I, II

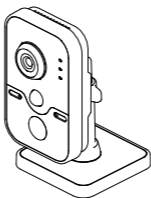

Figure 1-1 Type I Appearance



Figure 1-2 Type II Appearance

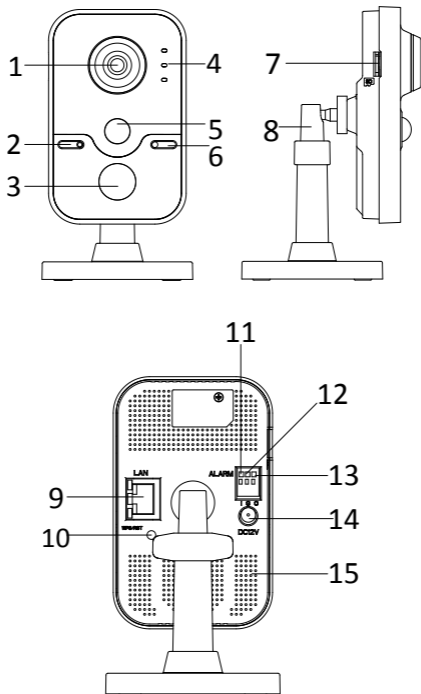

Figure 1-3 Overview

Table 1-1 Description

No.	Description	
1	Lens	
2	Microphone	
3	IR LED	
4	Indicator	Alarm: Solid red when the camera is armed; Solid blue when the camera is unarmed
		Status: Solid blue when the camera is added to the Guarding Vision
		Link: Flashing amber when network is connected; Unlit when network is disconnected
5	PIR(Passive Infrared) sensor	
6	Light Sensing	
7	Memory Card Slot	
8	3-axis Bracket	
9	10M/100M self-adaptive Ethernet interface & PoE	
10	WPS* (Wi-Fi Protected Setup)/Reset Button	
11	I: Alarm Input Interface	
12	G: Grounding	

No.	Description
13	O: Alarm Output Interface
14	Power supply interface (12 VDC)
15	Speaker

## 1.2 Type III

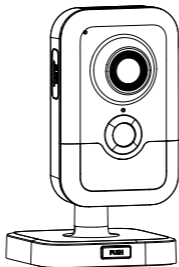

Figure 1-4 Type III Appearance

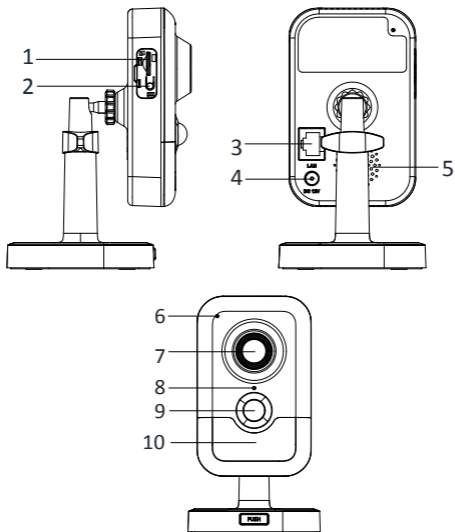

Figure 1-5 Type III Overview

Table 1-2 Description

No.	Description
1	Memory Card Slot
2	RESET/WPS*



## Network Cube Camera ▪ Quick Start Guide

No.	Description	
3	1 RJ45 10M/100M self-adaptive Ethernet port & PoE	
4	Power Interface (12 VDC)	
5	Speaker	
6	Microphone	
7	Lens	
8	Indicator	<ul style="list-style-type: none"> <li>● Solid red: the camera is starting</li> <li>● Slow flashing red: the network connection failed</li> <li>● Quick flashing red: the memory card error or other malfunctions</li> <li>● Flashing blue: the camera is connected to the network successfully</li> <li>● Quick flashing blue/Flashing red and blue alternately: the camera starts successfully and waits Wi-Fi configuration</li> </ul>
9	PIR(Passive Infrared) sensor	
10	IR LED	

**Note:**

- ❖ The indicator varies according to different device models.

- ❖ Press RESET about 10 s when the camera is power on or rebooting to restore the default settings, including the user name, password, IP address, port No., etc.
- ❖ Only certain models support WPS function.
- ❖ A wireless router with the WPS function is required to enable the WPS function of the camera. Refer the steps below.

**Steps:**

1. Press the WPS button on the router.
2. Press the WPS button (about 2 s) on the camera within 120 s you enable the WPS of the router to join in the wireless network.

**Note:**

- The WPS button works as a reset button only when you press it when the camera is powering on.
- Press the WPS button on the camera, and then press the WPS button on the router will work as well, and the expire time of WPS connection on the camera is 120 s.
- The link indicator blinks if the wireless connection succeeded.

## 2 Notice

Do not install the camera in the extreme whether condition.



Do not touch the lens with your finger.



Do not install the camera towards the strong light or in the unstable lightening condition.



Do not subject the camera to vibration, shock or heavy pressure.



High humidity may damage the camera hardware; put it in dry and well-ventilated place.

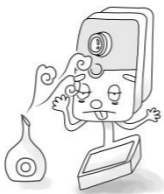

Under no circumstances should you submerge the camera in any type of liquid.



Electromagnetic radiation may affect the video data transmission and the image quality. Do not install the camera near electromagnetic radiation source.



## 3 Installation

---

### *Before you start:*

- Make sure the device in the package is in good condition and all the assembly parts are included.
- The standard power supply is 12V DC, please make sure your power supply matches with your camera.
- Make sure all the related equipment is power-off during the installation.
- Check the specification of the products for the installation environment.
- Make sure that the wall is strong enough to withstand four times the weight of the camera and the bracket.

For the camera that supports IR, you are required to pay attention to the following precautions to prevent IR reflection:

- Make sure that there is no reflective surface too close to the camera lens. The IR light from the camera may reflect back into the lens causing reflection.
- The foam ring around the lens must be seated flush against the inner surface of the bubble to isolate the lens from the IR LEDs. Fasten the dome cover to camera body so that the foam ring and the dome cover are attached seamlessly.

### 3.1 Memory Card Installation

This series of camera supports memory card installation. Follow the steps below to install the memory card.

### 3.1.1 Type I, II

**Steps:**

1. Insert the memory card into the card slot on the side of the camera.
2. (Optional) Push the inserted memory card to get it sprung out.

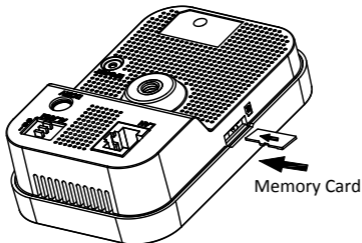

Figure 3-1 Install Memory Card

### 3.1.2 Type III

**Steps:**

1. Remove the memory card slot cover.
2. Insert the memory card into the slot.
3. (Optional) Push the inserted memory card to get it sprung out.
4. Replace the slot cover.

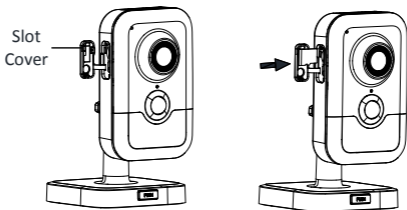

Figure 3-2 Install Memory Card

## 3.2 Type I, II Camera Mounting

### 3.2.1 Stand Mounting

**Steps:**

1. Take the bracket out from the package.

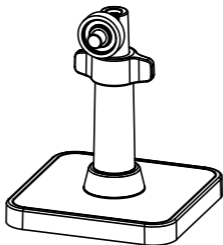

Figure 3-3 Bracket

2. Align the camera body to the bracket, and rotate the camera body to fix it with the bracket.

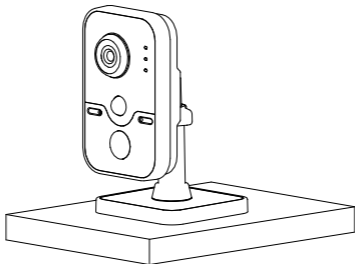

Figure 3-4 Install the Camera Body

3. Assemble the camera as the steps above, and put the camera on the flat surface.

### **3.2.2 Ceiling Mounting**

**Steps:**

1. Drill the screw holes according to the drill template.



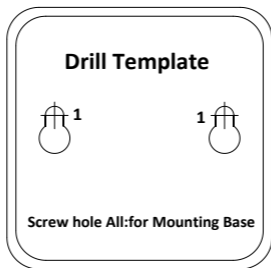

Figure 3-5 Drill Template

2. Disassemble the 3-axis bracket. Hold the base with one hand, and rotate the pole anticlockwise to disassemble the pole from the base.

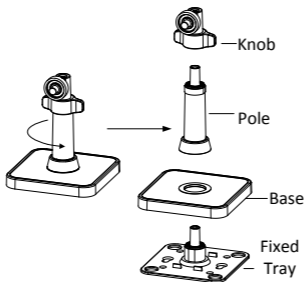

Figure 3-6 Disassemble the Bracket

3. Install the fixed tray to the ceiling with the supplied screws.
4. Install the base to the fixed plate.

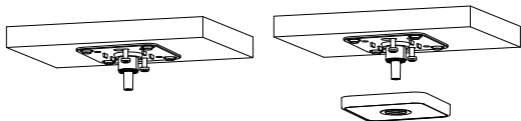

Figure 3-7 Install the Fixed Plate and Mounting Base

5. Install the camera to the bracket.

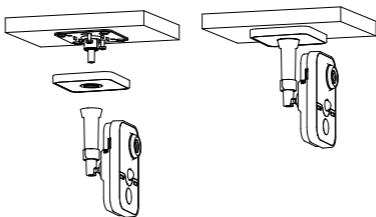

Figure 3-8 Install the Camera

6. Adjust surveillance angel
  - 1). Loosen the knob to adjust the panning position and tilting position.
  - 2). After adjusting the angle of the camera to the desired position, fasten the knob.

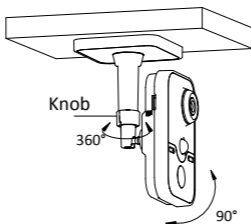

Figure 3-9 Adjust the Camera

### 3.3 Type III Camera Mounting

This type of camera supports ceiling mounting and wall mounting. The following describes the steps for the wall or ceiling mounting.

**Steps:**

1. Install the adapter plate to the wall or ceiling with the supplied screws.

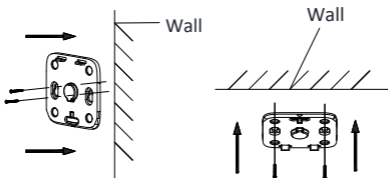

Figure 3-10 Install the Adapter Plate

2. Buckle the camera base into the adapter plate.

**Note:**

You are recommended to push into two buckles 1 and 2 first and then the third buckle 3. Then the camera can be fastened firmly on the base.

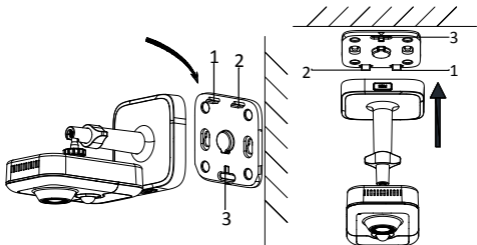

Figure 3-11 Buckle the Camera into Adapter Plate

3. Adjust surveillance angel.

- 1). Loosen the adjusting knob 1 to adjust the panning position and tilting position.
- 2). Loosen the adjusting knob 2 to adjust the rotation position.
- 3). After adjusting the angle of the camera to the desired position, fasten the two knobs.

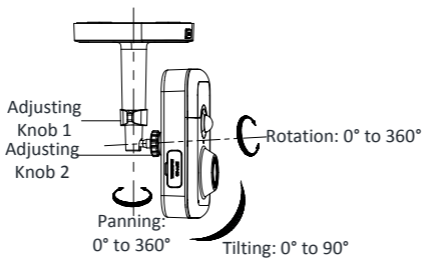

Figure 3-12 Adjust the Camera